

GRAC ROTO BONDER

**WITH CIRCULATING
SYSTEM**

RED RIVER MACHINERY
1-800-229-0759
<https://www.redrivermachinery.com>



L to R Unit Shown

**OWNER'S
MANUAL**

**DURO
DYNE**

**MACHINERY
DIVISION**

IMPORTANT FOREWORD

- 1) To ensure efficiency, the GBAC must be properly maintained. Carefully follow the clean-up procedures outlined in this manual. Should a valve handle become sluggish or stuck, remove the valve from the plumbing system, dismantle and clean it in warm water.
- 2) Check and adjust the air supply every week. (See Maintenance Section.)
- 3) The GBAC is designed for use with genuine Duro Dyne water-based adhesives.

IMPORTANT

Always follow manufacturer's recommendations for proper safety and handling procedures for all materials used in conjunction with this machine as outlined in Manufacturer's Safety Data Sheet (MSDS) for each product.

TABLE OF CONTENTS

IMPORTANT FOREWORD	2
PARTS LOCATION	3-5
OPERATION	6
CLEAN-UP	7-8
MAINTENANCE	8
WIRING DIAGRAM	8
ELECTRIC SYSTEM - SERVICING	9
CIRCULATION SYSTEM - SERVICING	10-11
PARTS LISTING	12

PUMP PARTS LOCATION

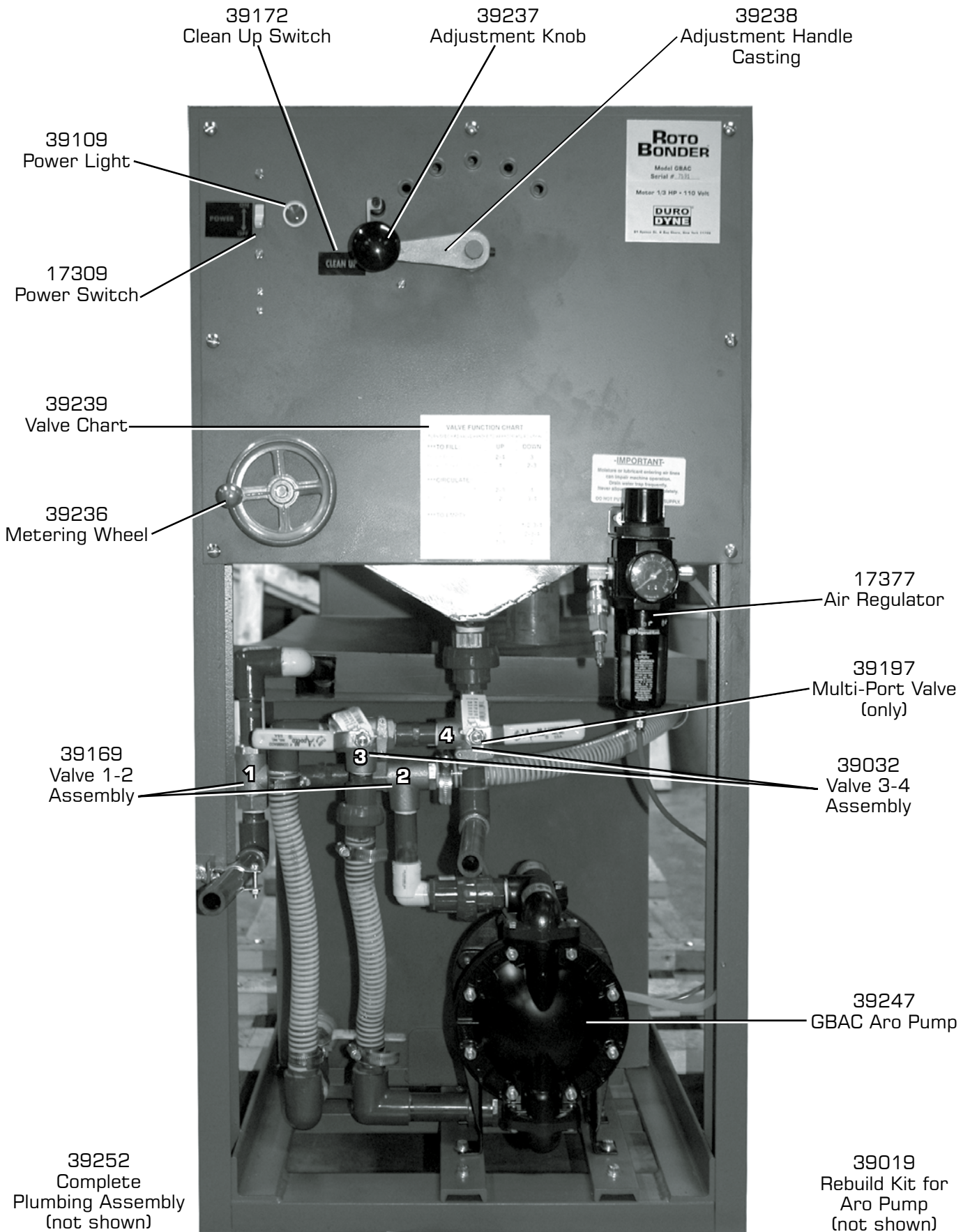

MOTOR PARTS LOCATION

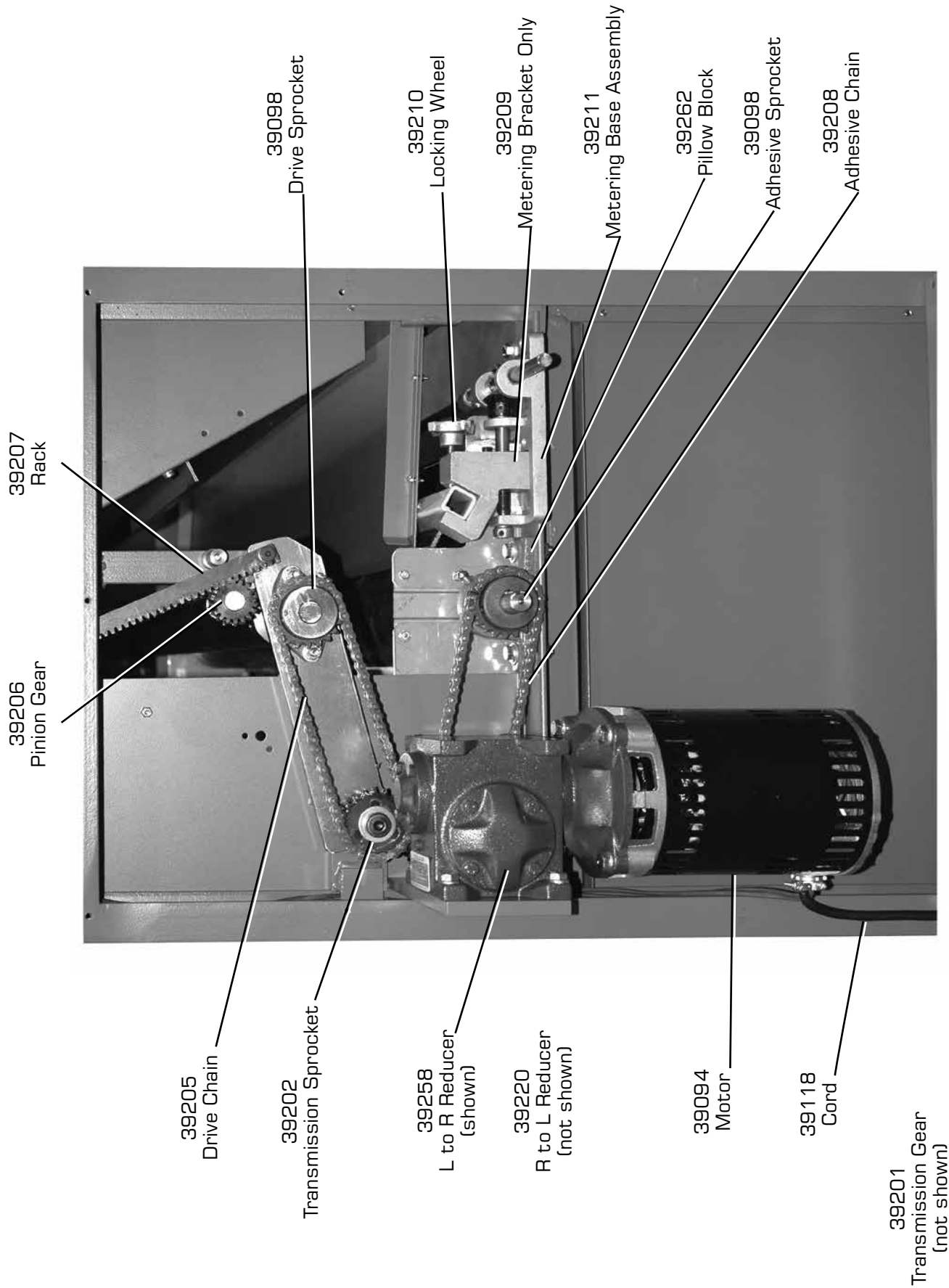

PARTS LOCATION

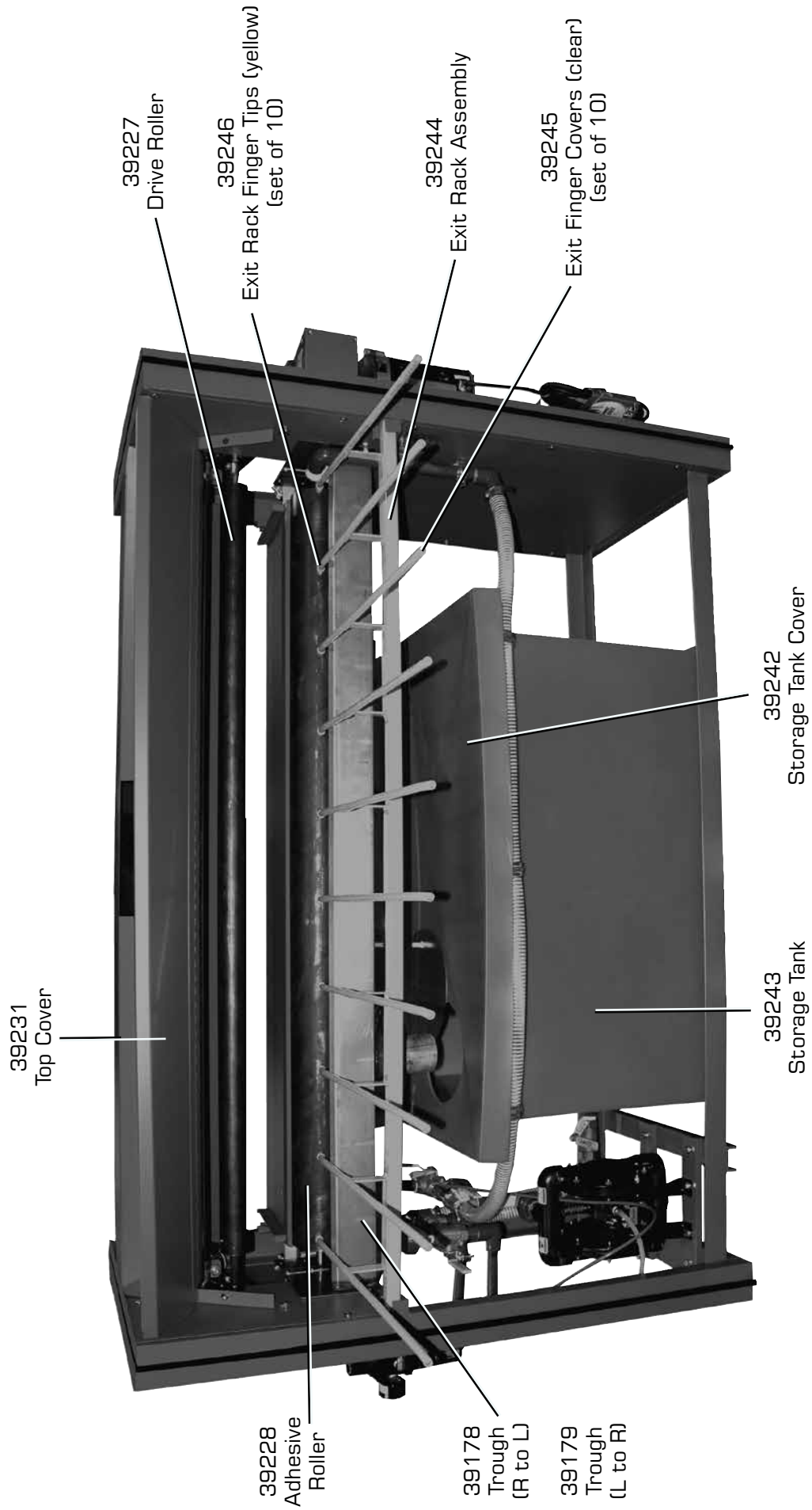
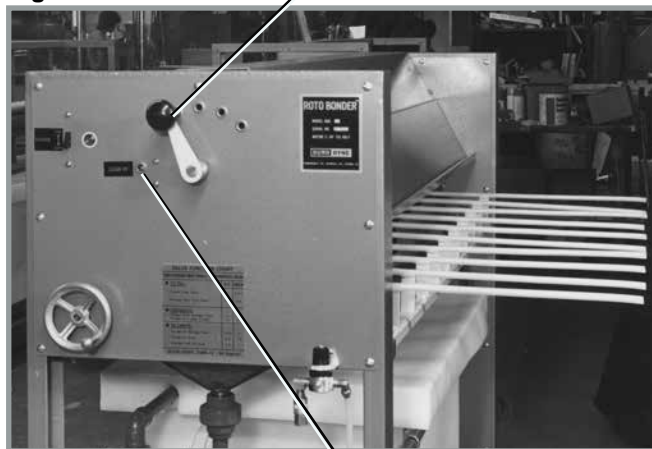

Fig. A

VALVE FUNCTION CHART		
TURN SPECIFIED VALVE HANDLE TO APPROPRIATE POSITION		
TO FILL:	UP	DOWN
Trough from Drum	2-4	3
Storage Tank from Drum	4	2-3
CIRCULATE:		
Trough from Storage Tank	2-3	4
Trough to Trough (in-out)	2	3-4
TO EMPTY:		
Trough to Storage Tank	-	1-2-3-4
Trough to Drum	1	2-3-4
Storage Tank to Drum	1-3	2

Selector Knob Assembly

Fig. C



Clean Position

- 1) **NOTE: Valve #5** is a normally open shut-off valve for models beginning with Serial #7132 (manufactured on 10-28-80)
- 2) Numbers appearing here refer to valve numbers on Valve Flow Diagram.

Fig. B Fig. D



OPERATION

- 1) Open the storage tank cover.
- 2) Set the multi-port valves to fill the storage tank from the drum as shown. To reduce fill time, turn the air regulator adjustment knob clockwise increasing adhesive flow. (This operation need only be repeated when the level of the adhesive in the storage tank is low and is being replenished. Keep the 55 gallon adhesive drum for later use as a water bath during clean-up.) See Fig. B.
- 3) Remove the storage tank cover. Stir the adhesive in the storage tank with a paddle or long wooden handle after removing the cover.
- 4) Set the valves so that the adhesive circulates to the trough from the storage tank as shown. Turn the air regulator knob counter clockwise (decreasing adhesive flow). Allow the adhesive to slowly spillover the spillgate into the storage tank during operation.
- 5) To regulate the amount of adhesive applied to the liner, turn off the power and lift the safety guard on the material entry side of the Roto Bonder. Raise the feed table and allow the table to drop perpendicular toward the floor. Turn the Selector Knob Assembly to the "Clean" position. With the power on, look into the machine. **Do not put your hands into the GBAC.** Turn the Metering Wheel (clockwise to decrease-counter clockwise to increase) to adjust the amount of adhesive that coats the adhesive roll. For maximum efficiency, the adhesive roll should be coated with a thin even coat of adhesive. With power off, replace the feed table and return it to its proper position. See Fig. C and D.
- 6) Switch the power on.
- 7) Adjust the GBAC for liner thickness by moving the Selector Knob Assembly [clockwise to increase (thicker liner), counter clockwise to decrease (thinner liner)] to adjust the roll clearances. See Fig C.
- 8) Feed the pre-cut fiberglass liner material into the Roto Bonder. Coated material is automatically carried through to the exit fingers.

Fig. A

VALVE FUNCTION CHART		
TURN SPECIFIED VALVE HANDLE TO APPROPRIATE POSITION		
TO FILL:	UP	DOWN
Trough from Drum	2-4	3
Storage Tank from Drum	4	2-3
CIRCULATE:		
Trough from Storage Tank	2-3	4
Trough to Trough (in-out)	2	3-4
TO EMPTY:		
Trough to Storage Tank	-	1-2-3-4
Trough to Drum	1	2-3-4
Storage Tank to Drum	1-3	2



- 1) **NOTE: Valve #5:** is a normally open shut-off valve for models beginning with Serial #7132 (manufactured on 10-28-80)
- 2) Numbers appearing here refer to valve numbers on Valve Flow Diagram.



CLEAN-UP

- 1) With power on, turn the metering wheel clockwise until the metering blade is against the adhesive roll. See Fig. D.
- 2) Set the multi-port valves so that the adhesive empties from the trough to the storage tank. When the trough is empty, back the metering blade away from the adhesive roll. Disconnect the air and turn off the power. See Fig. A and D.
- 3) With power off, lift the safety guards on the feed side of machine, and remove the metering bar and blade. Sponge clean the metering bar and blade, and reinstall it. Cover the adhesive in the storage tank with a thin film of water, and cover the tank.
- 4) Fill the empty 55 gallon adhesive drum with water for use as a water bath.
- 5) Turn the air on and place valves 1 and 4 to the up position, and valves 2 and 3 to the down position. Allow water to circulate (drum to drum) for at least (2) minutes. Proceed to Step 6. See Fig. A.
- 6) Turn the air on and adjust the valves to fill the trough with water from the 55 gallon drum. Then readjust the valves to circulate the water from the trough to the trough (in-out), for at least five minutes. Disconnect the air. Allow the water to remain in the stainless steel trough while the machine is not operating. See Fig. A.
- 7) Rotate the Selector Knob Assembly into the "Clean" position. This will allow the adhesive roll to rotate with the guard up. The adhesive roll will be rendered inoperative when the safety guard is lifted if the adjustment lever is not in the clean position. See Fig. C and D.
- 8) With the power on, lift the safety guard. Clean the adhesive roll while it rotates with a long handled brush from the feed side of the machine. **Do not put your hands in the GBAC.** When the roll is clean, be sure you reposition the adjustment lever. Do not attempt to clean the adhesive roll unless the adjustment lever is in the clean position. Do not render safety micro-switches inoperative. See Fig. C and D.
- 9) Turn the power off. (The metering blade will have to be readjusted when next used.)
- 10) Remove the exit rack and sponge it clean. Replace the exit rack.

EXTENDED CLEAN-UP

NOTE: If the machine is to be idle for several days there are additional clean-up procedures which must be followed.

- 1) With power off remove the exit rack and metering bar. With a long handled brush wipe down the trough. At this time the trough should still contain water.
- 2) Cover the 55 gallon drum of water. Turn the air on and empty the adhesive from the storage tank to the 55 gallon drum. Cover the adhesive in the 55 gallon drum with a thin coat of water and cap the drum. **See Fig. A**
- 3) Set the multi-port valves so that the water empties from the trough to the storage tank. **See Fig. A and B**
- 4) With the power off remove the feed table and tank cover. Set the multi-port valves to fill the storage tank from a convenient water bath, and with a long handled brush wipe the side of the storage tank. **See Fig. A**
- 5) Set the multi-port valves so that the water empties from the storage tank to a convenient water container. **See Fig. A**
- 6) Disconnect the air and power. Wipe the adhesive roll dry and return the feed table, exit rack, and metering bar to their proper position.

MAINTENANCE

- 1) Periodically grease the end bearings on the adhesive roll as well as the metering bar gearing.
- 2) The metering bar wiper blade can be removed and rotated 180° (end over end) as the blade shows wear.

AIR SUPPLY UNIT

- 1) To provide uninterrupted service, the air regulator assembly must be kept clean. Turn the drain valve clockwise to drain off any filter bowl accumulation before it becomes full. A visible coating of dirt or condensate on the filter element or erratic operation indicates cleaning is necessary. Wash the filter element and the regulator, in denatured alcohol and blow them out with compressed air. Clean the Filter Bowl With Household Soap Only.
- 2) Check for leaks in all air hoses.
- 3) Check and adjust the air pressure to 80 psi minimum. When reducing regulator pressure, pull the knob upward and turn the knob counter-clockwise. Cycle the machine before reading the gauge. To increase air pressure repeat the procedure turning the knob clockwise.

WIRING DIAGRAM

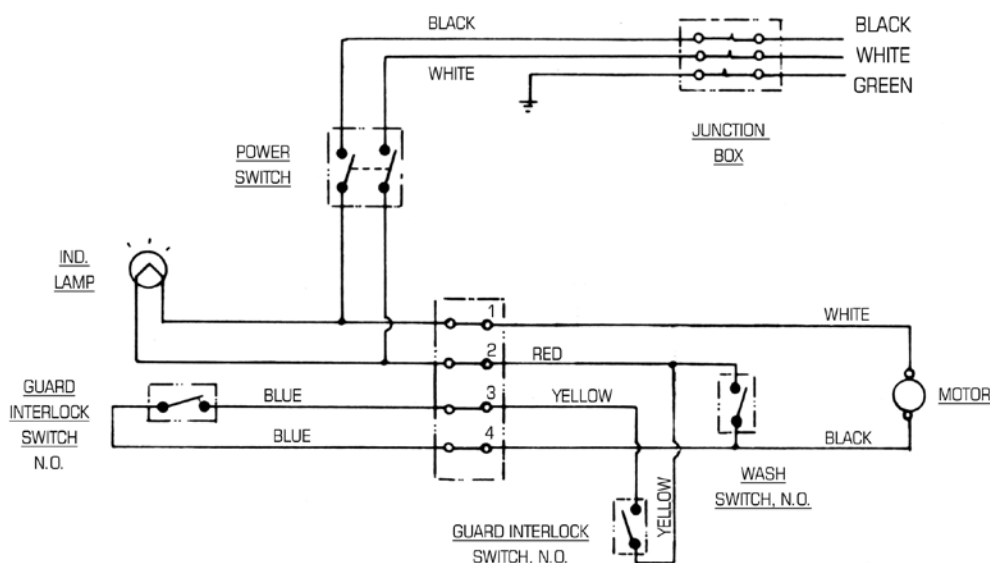

Fig. E

ELECTRIC SYSTEM SERVICING

It is necessary to use a voltmeter and an ohmmeter to perform the simple servicing procedures.

MEASURING RESISTANCE (OHMMETER)

- 1) Disconnect the power supply.
- 2) Set the ohmmeter at x1000 scale and keep it there for all resistance reading.
- 3) Touch the two probes together and "zero" the ohmmeter.

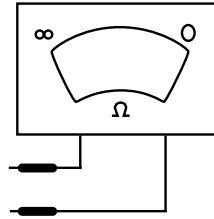

Follow the instructions below for reading resistance and voltage.

MEASURING AC VOLTAGES (VOLTMETER)

- 1) Set the voltmeter at the nearest scale above (never below) the voltage you wish to read.

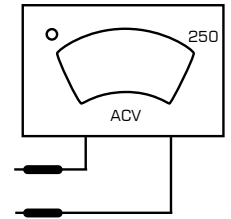

ELECTRICAL SERVICING

If the power switch is on and the rolls do not turn, follow the procedure outlined below.

- 1) Check the power supply for 110 volts.
- 2) **CAUTION: This troubleshooting step requires bypassing the safety switches. Be extremely careful to keep hands and clothing away from any moving parts or electrical connections.** Remove the top cover. Remove the screws retaining the inner panel with the guard interlock attached. Let this panel hang. Depress each microswitch placing a shim between the microswitch button and the flange the button protrudes through. With power on, read voltage across 1 and 2 on terminal strip.
If the voltmeter reads: 110 volts, proceed to Step 3.
If the voltmeter reads: "0" V: the problem is either broken wires from the power supply to the power switch or a defective power switch.

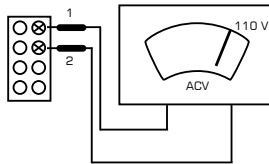

- 3) With the power on, read the voltage across 1 and 3 on the terminal strip.
If the voltmeter reads: 110 volts, proceed to Step 4.
If the voltmeter reads: "0" V: the problem is

either a faulty or misadjusted guard interlock or a broken wire from the terminal strip to the guard interlock. (Trace the wires from the terminal strip to the guard interlock.)

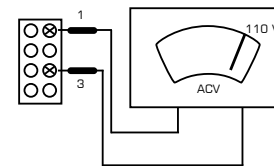

- 4) With the power on, read the voltage across 1 and 4 on the terminal strip.
If the voltmeter reads: 110 volts, proceed to Step 5.
If the voltmeter reads: "0" V: the problem is either a faulty or misadjusted guard interlock or a broken wire from terminal strip to the guard interlock. (Trace the wires to the guard interlock.)

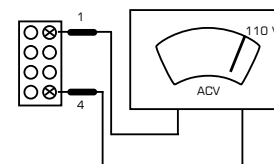

- 5) Replace the panel and the cover. Remove the motor side cover. With the power on, check whether the motor is turning or not. If the motor does turn, check that the keys and set screws in the sprocket are in position and tight. If the motor does not turn, check that the reducer is not bound up - replace the motor.

VALVE FUNCTION CHART		
TURN SPECIFIED VALVE HANDLE TO APPROPRIATE POSITION		
TO FILL:	UP	DOWN
Trough from Drum	2-4	3
Storage Tank from Drum	4	2-3
CIRCULATE:		
Trough from Storage Tank	2-3	4
Trough to Trough (in-out)	2	3-4
TO EMPTY:		
Trough to Storage Tank	-	1-2-3-4
Trough to Drum	1	2-3-4
Storage Tank to Drum	1-3	2

Fig. A

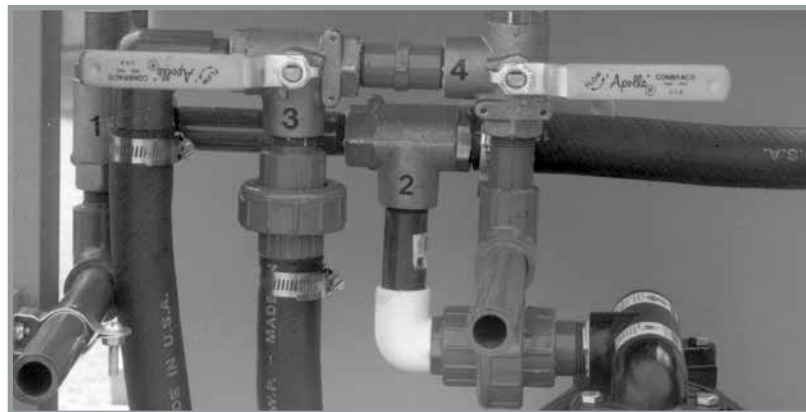
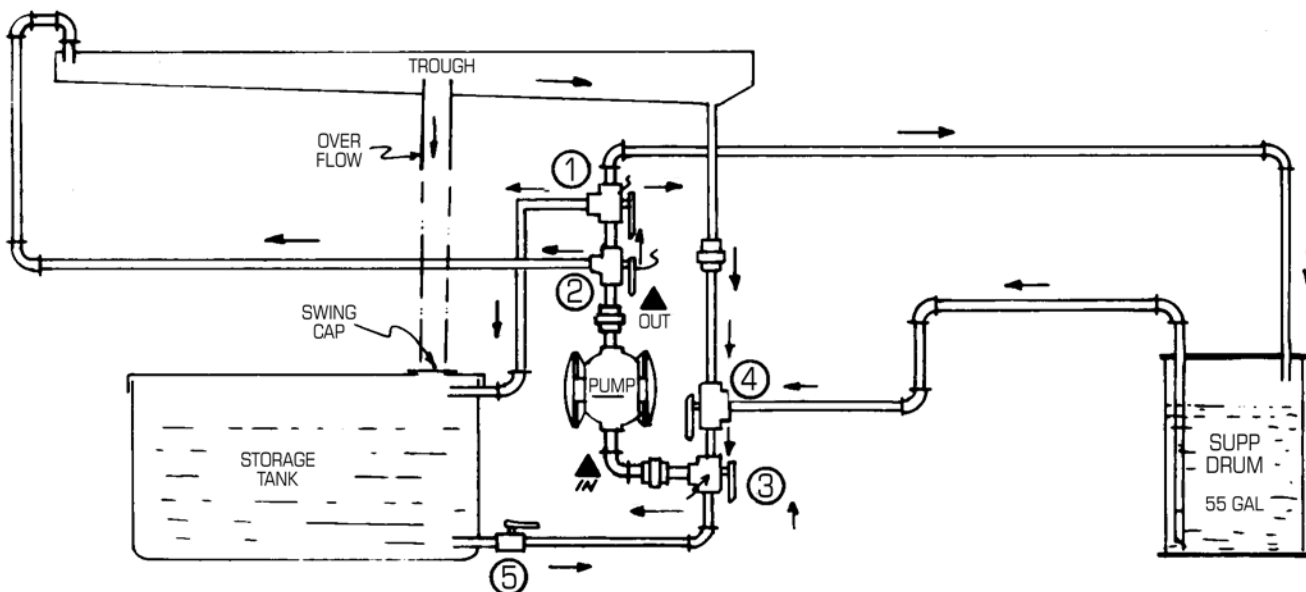

Fig. B

VALVE FLOW DIAGRAM

Fig. F



CIRCULATION SYSTEM SERVICING

The air is on but the adhesive is not circulating through the plumbing.

NOTE: Never force a valve handle. If a valve handle sticks, remove the valve and soak it in warm water.

- 1)** Check the valve setting against the function chart to insure that the valves are set properly. If the valves are set properly, proceed to Step 2.
- 2)** Check that number 2 valve is either in the up or down position. The circulation system will not work unless number 2 valve is in either position. Then proceed to Step 3.
- 3)** Check that the air-regulator unit is functioning according to the maintenance section of the Operating Instructions.
- 4)** Disconnect the air line that leads from the regulator to the pump. With the air line disconnected, check the air supply. If there is no air leading into the pump, proceed to Step 5. If there proves to be a good air supply, reconnect the air line and proceed to Step 6.
- 5)** Disconnect the air line leading to the air regulator and check the air supply. If there is a good air supply to the regulator, replace the regulator. If there is no air supply to the regulator, the problem is independent of the GBAC.
- 6)** Fill a bucket with warm water. Place the GBAC input hose in the warm water and set the valves to fill the trough from the drum. Activate the pump. If the water begins to pump into the trough, deactivate the pump immediately and proceed to Step 8. If no water pumps to the trough, proceed to Step 7.
- 7)** Fill a bucket with warm water. Place the GBAC input hose in the warm water and set the valves to fill the storage tank from the drum. Activate the pump with air. If the water begins to pump into the storage tank, deactivate the pump immediately and proceed to Step 8. If the water does not circulate, proceed to Step 9.
- 8)** Remove the bucket of warm water and set the multi-port valves to circulate the adhesive from the drum to the trough. If the adhesive will not circulate, proceed to Step 9.
- 9)** Set the multi-port valves so that adhesive circulates from the storage tank to the trough. Activate the pump and observe whether adhesive is flowing into the trough. If there is an adhesive flow, proceed to Step 12. If there is no adhesive flow, proceed to Step 10.
- 10)** Disassemble the plastic union located beneath valve 2. Set the multi-port valves so that glue circulates from the storage tank to the trough. If adhesive is pumped from the union, disconnect the air and replace the valve assembly 1 and 2.
Note: It is important that all surfaces on the valves and the unions be free of glue residue before reassembly. If the glue is not pumped out from the union, disconnect the air, reassemble the union and proceed to Step 11.
- 11)** Set the multi-port valves so that the adhesive empties from the tank to the drum. Activate the pump. If the adhesive exits the machine from the out port, replace valves number 3 and 4. (Order an assembly.) Close valve number 5 if supplied, before disassembling valve number 3 and number 4. After replacing valve number 3 and number 4, open valve number 5. If the adhesive is not pumped out the exhaust port, proceed to Step 12.
- 12)** Set the multi-port valves so that the trough is filled from the drum. Activate the pump. If adhesive is pumped into the trough, replace valve assembly number 1 and number 2. If adhesive does not pump into the trough, proceed to the pump service manual.

GBAC SPARE PARTS LIST

NOTE: When ordering spare parts include serial number of machine.

ITEM#	DESCRIPTION	ITEM#	DESCRIPTION
17309	Power Switch	39213	Metering Bar Assembly
17377	Air Regulator Assembly	39214	Metering Blade
39001	Air Sleeve Valve	39215	Blade Retainer
39003	Street Elbow Fitting	39219	Sleeve Joint Assembly
39004	Male Elbow Fitting	39220	Speed Reducer - R to L
39006	Selector Knob Assembly Consisting Of:	39225	Pinion Shaft Collar
39237	Knob	39226	Pinion Shaft
39007	Shaft	39227	Drive Roller
39008	Spring	39228	Adhesive Roller
39009	Retainer	39229	Leveling Feet (4/Set)
39238	Adjustment Casting	39230	Universal Joint
39019	Pump rebuild kit ARO only	39231	Top Cover Assembly
39032	Valve 3-4 Assembly	39237	Adjustment Knob
39094	Motor (Electric)	39260	Connecting Rod (R-L 57 1/2")
39098	Drive Sprocket	39261	Connecting Rod (L-R 59 1/2")
39098	Adhesive Drive Sprocket	39271	Flat Pillow Block
39109	Indicator Lamp	39272	GBAC Trough Strainer
39118	Line Cord	39233	Side Panel (Operator's Side)
39169	Valve 1-2 Assembly	39236	Metering Wheel & Handle Assembly
39172	Guard Interlock (Switch)	39238	Selector Handle Consisting Of:
39172	Clean Up Switch	Handle	
39176	Motor Side Cover	Setscrew	
39177	Feed Table Assembly	39239	Valve Function Chart
39178	Trough (R to L)	39242	Tank Cover
39179	Trough (L to R)	39243	Storage Tank
39201	Transmission Gear Assembly	39244	Exit Rack Assembly Consisting Of:
39202	Transmission Sprocket Assembly	39245 - 1 Set Rack Plastic Finger Covers (10/Set)	
39205	Drive Chain Link	39246 - 1 Set Rack Plastic Finger Tips (10/Set)	
39206	Pinion Gear	39247	Pump (Aro)
39207	Rack	39252	Complete Plumbing 1-2 and 3-4 Assembly
39208	Adhesive Drive Chain & Link	39258	Speed Reducer - L to R
39211	Metering Base Assembly Consisting Of:	39262	Pillow Block
39209	Metering Bracket		
39210	Locking Wheel		
39212	Metering Shaft		
39216	Mitre Gear (Pr.)		
39217	Metering Bushing 1/2 ID (3 set)		
39218	Metering Collar		
		SANDPIPER PUMP PARTS	
		39015	Pump Balls (4)
		39016	Flange Gasket (4)
		39017	Manifold Gasket (2)
		39018	Pump Diaphragm Set (1)

MACHINERY DIVISION
© 2008 Duro Dyne Corporation
Printed in USA 09/2008
BI039405

